

INTRODUCTION

ELECTRICITY HAS BECOME AN IMPORTANT ELEMENT OF EVERY NORTH AMERICAN HOME. IT PROVIDES LIGHTING, HEATING AND POWER FOR ELECTRIC MOTORS AND ELECTRONICS SUCH AS CONTROLS AND COMPUTERS. OUR HOMES WOULD NOT BE NEARLY AS COMFORTABLE OR AS CONVENIENT WITHOUT ELECTRICITY.

ON THE OTHER HAND, ELECTRICITY IS DANGEROUS. IT HAS TO BE INSTALLED AND USED PROPERLY TO BE SAFE. ELECTRICITY IS TRICKY BECAUSE IT IS INVISIBLE, IT IS COMPLICATED AND IT CAN KILL.

1.0 The Basics

DESCRIPTION Electricity can provide us with heat, light and power as invisible electrons move in a circuit through wires and appliances. We can control whether it gives off mostly light or mostly heat by using light bulbs or electric heaters. Electricity can also drive electric motors with fast changing magnetic fields.

Where does electricity come from?

Electricity is provided by utilities. It can be generated by moving water (e.g. Niagara Falls generates hydroelectric power) burning fossil fuels like coal or from nuclear reactions, for example. As we look for more environmentally sensitive ways to generate electricity, solar, wind and geothermal power sources are becoming more common. Batteries may be used to store and deliver power.

Electricity is distributed through communities by a grid of overhead and/or underground wires. Electricity can be alternating current or direct current. Our discussion will focus on alternating current, since that's what we find in homes.

Let's start with a brief description of four common electrical terms:

V = Voltage, measured in volts. This represents the electrical force that is available.

I = Current, measured in amps (amperes). This represents the amount of electricity flowing.

R = Resistance, measured in ohms. This is a measure of the opposition to electrical flow.

P = Power, measured in watts (1 kilowatt is 1000 watts). This represents the rate at which work is done.

The table below shows the relationship between these four terms.

Table 1 – Electrical Basics			
V=Voltage (volts)	P=Power (watts)	I=Current (amps)	R=Resistance (ohms)
Formulas: $V=IR$ $P=VI$			

1.1 Voltage

DESCRIPTION Electricity flows because there is a pressure (volts) being applied to a circuit, supplied from the local utility. Utilities provide 240 volts to homes, in two 120-volt bundles.

1.2 Current

DESCRIPTION The electric current in a circuit, measured in amps (or amperes), is the rate of flow of electricity that results when a light bulb, heater or appliance is turned on. The amount of current is a result of the amount of pressure (volts) and the resistance to flow (ohms). The larger the pressure, the greater the flow. The larger the resistance, the smaller the flow.

CONTROLLING THE FLOW Two dangerous things can go wrong with the flow of electricity:

1. Too much flow results in overheating and possibly a fire. We can get too much electricity flowing if too many appliances are plugged into one circuit. There are other ways too much electricity can flow, but let's leave it at that. If everything works properly, fuses and circuit breakers turn the electricity off when too much electricity flows.
2. Electricity may flow where it is not supposed to. This is where people get electrical shocks. It happens when you drop the hairdryer or radio into the bathtub, you stick a key into an electrical outlet, or you drive a nail into a live electrical wire, for example. A flow of less than one amp can kill you.

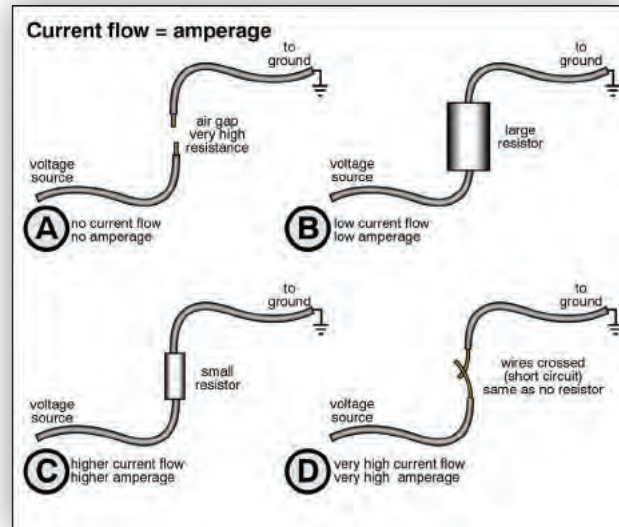

1.3 Resistance

DESCRIPTION Resistance, measured in ohms, prevents electricity from flowing. We use resistance to control whether electricity flows, and if so, how much. Things that slow down or resist electrical flow are called resistors or insulators. Things that allow electricity to flow easily are called conductors.

CONDUCTORS Good electrical conductors have relatively low resistance. Conductors are useful for moving electricity from one place to another. Most metals including copper and aluminum wiring are good conductors. Aluminum is not quite as good as copper, but is less expensive. Water is a very good conductor, which is why it's dangerous. When electricity contacts water, it often flows where it shouldn't. The human body is a pretty good conductor, which is unfortunate for us.

INSULATORS HAVE HIGH RESISTANCE When we don't want electricity to flow, we use things with lots of resistance. These things are called insulators. Air, glass, wood, rubber and most plastics are good insulators. Homes use copper wire (a conductor) to move electricity around. We wrap the wire in a plastic insulator, so the electricity stays within the wire, making it safe to touch.

1.4 Power





DESCRIPTION Power is measured in watts or kilowatts (1000 watts), and is calculated by multiplying the voltage (volts) times the current (amps). A house with a 240-volt power supply and 100 amp main fuses has 24,000 watts. This is commonly referred to as 24 kilowatts (because one kilowatt is 1000 watts). A 1200-watt hair dryer plugged into a 120-volt circuit will result in a 10-amp electrical current flow.

KILOWATT-HOURS 1 kilowatt (kW) is 1000 watts (W). Electrical consumption in your home is measured in kilowatt-hours (kWh). If you use 1000 watts (1 kilowatt) for one hour, you consume one kilowatt-hour (kWh). This is how we buy electricity from the utility. The electric meter records kilowatt-hours used in the house. If each kWh costs ten cents and we use 500 kWh in a month, our electrical bill for that month is \$50.

NEXT STEPS Let's have a quick look at wire size, fuses and circuit breakers before we start to look at the house system in more detail.

1.5 Wire Size (Gauge)

DESCRIPTION We use wires to move electricity around the house because wires are good conductors. The amount of current (amps) a wire can safely carry is determined largely by its diameter. A larger wire can carry more current. Typical household circuits are designed to carry 15 amps, and 14-gauge copper wire will do this safely. The illustration shows common wire sizes and the typical size of fuse or breaker that is used to protect them. Aluminum is not as good a conductor of electricity, and a larger wire has to be used to carry the same amount of electricity as copper. It's very confusing, because larger wires have a smaller number gauge. We think electricians do this to make it hard for us.

<p>14 AWG copper wire</p>  <p><u>common uses:</u> most circuits for lighting and receptacles, electric baseboard heaters</p> <p><u>typical fuse/breaker size:</u> 15 amps</p>	<p>10 AWG copper wire</p>  <p><u>common uses:</u> electric clothes dryers, air conditioners, water heaters</p> <p><u>typical fuse/breaker size:</u> 30 amps</p>
<p>12 AWG copper wire</p>  <p><u>common uses:</u> some receptacles, electric baseboard heaters, small air conditioners</p> <p><u>typical fuse/breaker size:</u> 20 amps</p>	<p>8 AWG copper wire</p>  <p><u>common uses:</u> electric stoves and ovens</p> <p><u>typical fuse/breaker size:</u> 40 amps</p>

1.6 Breakers and Fuses

DESCRIPTION When too much electricity flows, things can overheat and we might have a fire. Fuses and circuit breakers turn off the electricity when there is too much flow. They are the lifeguards of the electrical system. Let's look at a normal household circuit.

A 14-gauge wire with 120-volt pressure can safely carry about 15 amps before things get too hot. We put a fuse or breaker at the beginning of the circuit to shut the circuit off if more than 15 amps flow. A 1200-watt hair dryer will cause about 10 amps to flow. If we plug a 1200-watt curling iron into the same circuit, another 10 amps will flow. Now we have 20 amps flowing and the wire is going to get too hot. That's when the circuit breaker should trip or the fuse should blow. Losing power is a nuisance, but it prevents a fire.

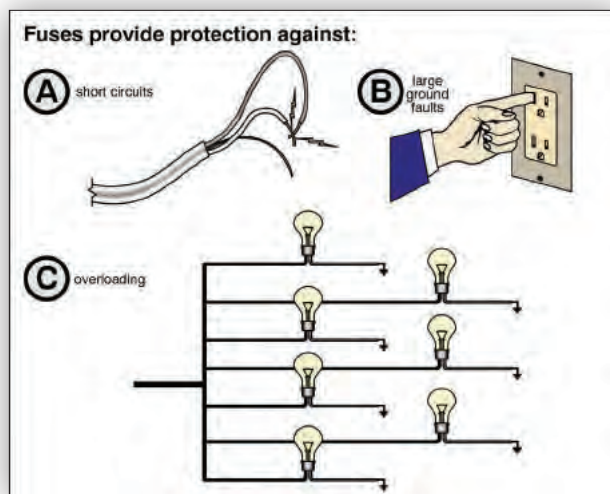

OVERCURRENT PROTECTION DEVICES The fancy name for circuit breakers and fuses is overcurrent protection devices. Both fuses and breakers perform the function equally well. A circuit breaker can be turned back on like a switch after the overload situation is corrected. A fuse 'blows' and has to be replaced. Most modern electrical work in homes uses circuit breakers.

NEXT STEPS For the rest of this section, we'll look at electricity in the home. We'll start with how electricity gets into the house and spend some time on the panel before looking at the wire carrying electricity through the house. We'll finish with the switches, light fixtures, junction boxes and electrical receptacles at the end of the circuit.

Some people think of electricity as a tree. The trunk is the bundle of electricity coming into the house from the utility. The trunk is split into branches at the panel. You can think of each circuit in the home as a tree branch. Each circuit typically has some lights, switches and receptacles. You can think of these as the twigs on each branch.

2.0 Service Entrance

2.1 Service Drop and Laterals: Getting Electricity to the House

DESCRIPTION – SERVICE DROP AND SERVICE LATERALS A typical house has 240-volts, brought in through overhead (service drop) or underground wires (service laterals) from the utility. There are three wires. The live black and red wires each bring 120 volts to the home, and the white wire is neutral. It does not bring any voltage to the home, but completes the circuit.

These wires may be copper or aluminum. The potential between the black and white wires is 120 volts, between the red and white is 120 volts, and between the black and red is 240 volts. (Incidentally, the “red” wire often has black sheathing, just to make things confusing). The size of the service entrance cable determines how much electricity is available to the house.

The service drop and service laterals are typically the responsibility of the utility. Everything beyond this point is the responsibility of the homeowner. Service drops connect to the service entrance conductors, which are typically in conduit running down the outside of the building.

Underground service wires (laterals) are in a conduit, typically buried one and a half to three feet deep. The conduit comes up to the electric meter on the outside of the building. From the electric meter, the conduit goes into the building.

Overhead service drops may be attached to the side of the building, and come down to the electric meter in a conduit (or cable), again along the outside of the building. On shorter buildings, they sometimes come in above the roofline and enter an electrical mast that sticks up above the roof. The wires go into the mast, which forms a conduit, again running down the outside of the building.

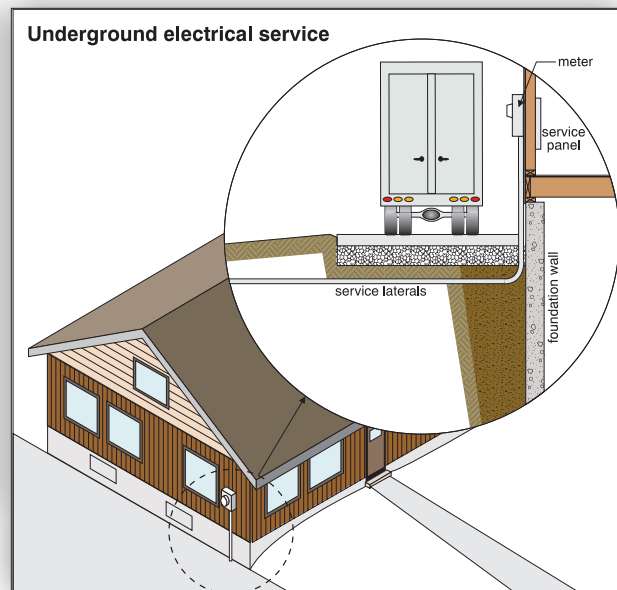
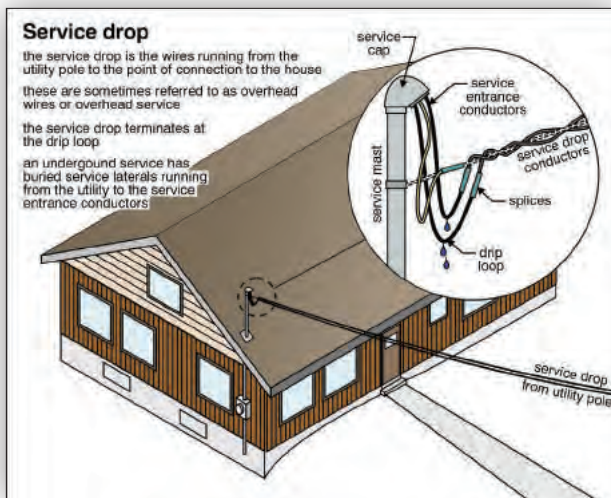

- 120-VOLT AND 240-VOLT CIRCUITS** Typical household circuits are 120-volt. Some 120-volt circuits use a black wire and white wire. The others use a red wire and a white wire. Large appliances that need lots of electricity, like stoves, clothes dryers, water heaters and air conditioners, use 240-volt circuits. They use a black wire, a red wire and a white wire, typically.
- SERVICE SIZE** The size of the electrical service to the house (100 amps, 200 amps, etc.) is determined by the size of the wires coming to the house. We'll talk more about this shortly.

Common Problems with Service Drops and Service Laterals

What can go wrong as we bring electricity to the house? There are three common problems – damage, improper location, and moisture problems. We will focus on the overhead wires, because there's not much we can see of underground wiring coming into the house. Remember, problems with the service drop are usually the responsibility of the utility.

- DAMAGED WIRE** Wire can be damaged by tree branches or may deteriorate due to weathering. Where damage such as frayed insulation is noted, the utility (electric company) should be notified.
- CLEARANCE** Wires that are too low can be hit by vehicles. You don't want your moving truck taking out your electrical service before you move into the house. Overhead wires should be about 12 feet above ground level. We don't want people leaning out windows or standing on decks to be able to touch these overhead wires. Wires should be kept at least three feet away from windows, and roughly ten feet above decks. Again, where clearance is not adequate, the utility should be notified.
- WATER** Water on the overhead wires is not a problem. However, once the water gets into the conduit that goes into the home, it is a problem.
- POOR CONNECTION TO SERVICE ENTRANCE CONDUCTORS** The service drop wires may not be well-connected to the service entrance conductors. This can interfere with the house electrical service and create a dangerous situation.

2.2 Service Entrance Conductors

- DESCRIPTION** The overhead service drop is typically the responsibility of the utility. These wires connect to the service entrance conductors, which are the responsibility of the homeowner. This hand-off point from the utility wires to the homeowner wires is sometimes called the service point. The service entrance conductors are typically in a metal or plastic conduit that runs down the outside of the house. The conduit protects the wires from mechanical damage and moisture. Some homes have a service entrance cable rather than a conduit.
- DRIP LOOP** A drip loop prevents water entering the service conduit. The service wires form a loop below the service head, which allows water to drip off the wire. That keeps the water out of the conduit.

CONNECTION TO BUILDING Remember the service drop has to be at least 12 feet above the ground. On tall buildings, the service is connected to the side of the building. The service entrance conductors form a drip loop and then enter a conduit that runs down the side of the building. On shorter buildings, the drip loop attaches to a service mast (conduit) that extends above the roof and carries the service entrance conductors down along the outside of the building.

METERS The service conduit carries the service entrance conductors through the electric meter so we can pay for our electricity. Meters are typically on the outside of the home close to the front of the building to facilitate meter reading by a utility representative. Modern systems are eliminating the need for a human meter reader.

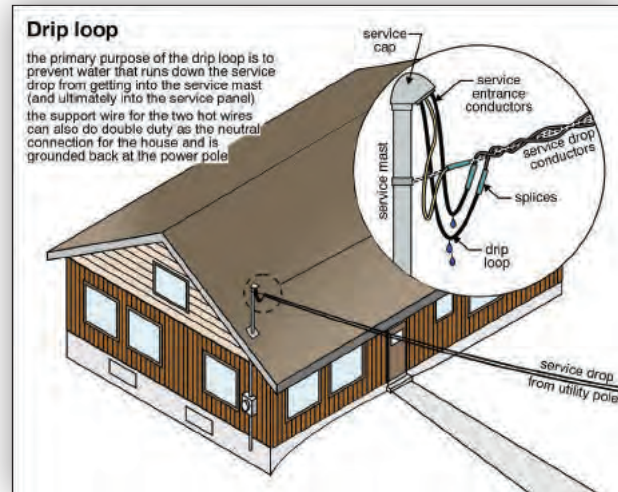

INSIDE BUILDING Once inside the building, the conduit must be kept as short as possible, ideally going straight into the box. This avoids exposing the conduit to mechanical damage.

Common Problems with the Service Entrance Conductors

DRIP LOOP MISSING/INEFFECTIVE Sometimes the drip loop is missing or does not create a low spot for water to run off the service entrance wires. This results in water getting into the conduit, which can run into the service box or panel inside the house, causing rust and poor electrical connections.

SERVICE CAP NOT WATERPROOF The service entrance conductors have to enter the conduit through a weather-tight cap. Water can cause rust and poor connections. Where there is evidence of water penetration, repairs should be made.

MAST DAMAGED/ TOO SHORT/POOR LOCATION The service mast above the roof has to be well secured and free from rust or rot. Weaknesses here should be corrected promptly to maintain the integrity of the electrical service drop and service conductors. The mast should be tall enough (at least three feet typically) to keep the wires clear of the roof, so they will not interfere with re-roofing or maintenance activities. We also try to avoid having overhead wires running across roofs. We don't want someone up on the roof cleaning the gutters or repairing a leak to touch these wires.

POOR FLASHING AT ROOF	Where the mast penetrates the roof surface, the opening should be protected with a flashing that prevents water getting into the roof structure. Where this is not effective, there may be water damage to the building.
DAMAGED/ POORLY SECURED	The conduit should be intact and well secured to the building. Rust, cracks, loose connections and deformities in the conduit should be corrected.
COVERED BY SIDING	The service mast or conduit should not be covered by siding, so it will not be damaged inadvertently and so it can be inspected easily.
POOR SEAL AT METER/WALL	The conduit should be sealed at the meter and where it passes through the wall to prevent water penetration.

2.3 Service Size

DESCRIPTION The service size is determined by the size of the wire coming from the street to the home. It's often hard to determine the wire size, since it is in a conduit. The size of the main fuses or breakers is a good indication of service size.

As the power enters the house, it goes into a service box, which has two fuses or two circuit breakers (or one big breaker). One is for the black wire and one is for the red. No breaker or fuse is used on the neutral wire. The size of the fuses or breakers should match the wire capacity. (100 amps, 200 amps, etc.) See Table 2 below for ratings of various service entrance wires.

A service box with fuses might have two 100-amp fuses. This indicates a 100-amp service, not 200 amps. You can't add them together. One of the fuses protects the black wire and the other one protects the red wire.

The rating stamped on the meter box or on the service box is not always a good indicator of the electrical service size.

HOW MUCH ELECTRICITY IS ENOUGH? Every house gets 240 volts. The amount of electricity available is described by the number of amps the system can safely deliver. 100 amps is a common electrical service for an average home. Larger houses or houses with big electrical demands like electric heat might have 150 or 200 amp services. The largest residential electrical service we typically see is 400 amps. Some older homes have 60-amp services. While this may be serviceable for some homes and lifestyles, 100 amps is commonly considered a minimum.

Table 2 – Typical Service Entrance Sizes

Minimum Wire Size USA		Service Size (amps)	Minimum Wire Size Canada	
Copper	Aluminum		Copper	Aluminum
4	2	100	3	2
2	1/0	125	2	2/0 (1/0)
1/0	2/0	150	1/0	3/0
2/0	4/0	200	3/0	250 MCM

Note: Variations are possible, depending on type of wire, temperature rating, etc.

Table 3 indicates what typical electrical appliances need to operate. The size of the service needed for the house depends on the number of electrical appliances. Some of the appliances that can tax an electrical service include electric heaters, saunas, and hot tubs. It is the simultaneous use of appliances that causes problems, and this is dependent on lifestyle. Larger families are likely to use more electricity at the same time, and may need a larger electrical service than a smaller family in the same house.

Table 3 –Typical Power and Current for Household Appliances		
	Watts	Amps
Stove and oven	9600	40
Clothes dryer	5000	20
Central air conditioner	5000	20
Electric water heater	3000	12.5
Kettle	1500	12.5
Toaster	1200	10
Microwave oven	1500	12.5
Coffee maker	1200	10
Dishwasher	1200	10
Iron	1500	12.5
Portable electric heater	1500	12.5
Window air conditioner	1200	10
Central vacuum	1500	12.5
Hair dryer	1800	15
Portable vacuum cleaner	1400	12
Washing machine	500	4.2
Furnace fan	250	2
Blender	360	3
Refrigerator	700	6
Television	120	1
DVD player	20	0.2
Stereo	120	1
Desktop computer with monitor	180	1.5
Laptop computer	60	0.5
60 watt incandescent light	60	0.5
14 watt compact fluorescent light	14	0.1
1/4 horsepower motor	700	6
1/2 horsepower motor	1000	8

The Common Problem with Service Size

100 amp services are common and the minimum acceptable for most homes. How much electricity you need depends on the size of the house, and the number of electrical appliances.

SERVICE TOO SMALL A house with an undersized electrical service is not a safety concern, but it is an inconvenience. An electrical service that is marginally sized may suffer blowing of the main fuses or breaker. The breakers can simply be reset by the homeowner, but fuses usually have to be replaced by the utility or an electrician. The entire house is often without electricity while waiting for a service call. This is one reason modern installations use a main breaker rather than fuses.

Changing the service size typically means new wires from the street to the house, new conduit, a new meter and usually a new service box. Replacing underground wires is more expensive than replacing overhead wires.

Most modern homes have a combination panel that incorporates the service box (with the main circuit breaker) with a panel housing the breakers that go to the individual circuits. When a service in an existing home is upgraded, a combination panel is typically installed. A good installation includes a panel with room to add more circuits in the future.

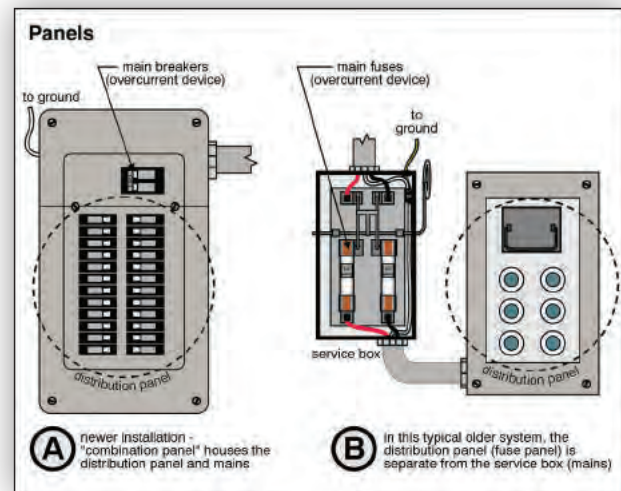

2.4 Service Box (Service Equipment)

DESCRIPTION The service box includes a circuit breaker that can be used to shut off all the power in the house (newer), or a switch with a handle located on the outside, and the service fuses inside (older). This is your emergency shut-off for all the electricity in the home. The service box may stand alone, although in modern homes, a combination panel (service panel) is common. This includes the breakers for the individual branch circuits.

HOUSE POWER LEFT ON The main switch or breaker is not shut off during a home inspection, since it would shut down the entire house. This can disrupt clocks, timers and computers, for example, and can result in damage to some motors and compressors.

Home inspectors don't remove the cover for the main breakers in a combination panel for safety reasons.

Not all homes have a single service box. Some have a number of different points where electricity can be turned off. In many areas, up to six different disconnect points are acceptable to turn off all the electricity in the house.

Common Problems with the Service Box

UNDERSIZED BOX The service box rating must be at least as large as the service entrance wires, and the fuses or breakers inside. For example, if a house has a 150-amp service, a box rated for only 100 amps is not acceptable.

UNDERSIZED BREAKER OR FUSE The fuse or breaker rating should match the wires' current rating (ampacity) to ensure an adequate supply of electricity to the home and to ensure proper protection for wires. If improperly sized, the main fuses or breakers should be replaced.

MISMATCHED FUSE SIZES The two main fuses in the service box should be the same size to properly protect the wires and ensure the supply of electricity to the home is adequate. If they are not, an electrician should be engaged to correct the situation.

POOR CONNECTIONS/ EVIDENCE OF OVERHEATING Poor connections may lead to overheating and should be corrected. In some cases it is necessary to replace the service box itself.

DAMAGED/ POORLY SECURED If the main switch or breaker handle is inoperative or damaged, it should be replaced. Similarly, if the box is rusted or damaged, it should at least be checked by an electrician. The service box should be re-secured to the wall if it is loose, to prevent poor electrical connections.

RUST Moisture in the box leads to rust, which damages the box and can result in unsafe electrical conditions.

POOR ACCESS OR LOCATION The service box should be accessible and in a dry location. The service box should be roughly five feet above the floor and have three feet clear in front of the box. Service boxes should not be located in clothes closets, bathrooms or stairwells.

NEXT STEPS Before we move on to talk about the panel that breaks the trunk of the tree up into branches, let's have a look at a safety system called grounding.

2.5 System Grounding

DESCRIPTION The purpose of grounding is to give electricity a safe place to go if it gets out of control. When people touch live electrical things, they get an electrical shock, and in some cases they die. Grounding helps prevent that.

Until roughly 1960, grounding was only found at the service panel. Since then, it has been used on all branch circuits, including lights and electrical outlets. A ground wire is a wire that provides a safe path for stray electricity.

Generally speaking, the grounding wires are connected to metallic parts of an electrical system that are not supposed to carry electricity. These metal components (panels, switch boxes, light boxes, etc.), are close to electricity, and if something goes wrong, the metal cabinet could become live. A person touching the cabinet would get a shock. Connecting the ground wire to the metal cabinet ensures that if someone touches the cabinet, he or she will not get a shock, even if a live wire inside is touching the cabinet.

WHERE DOES THE ELECTRICITY GO? The stray electricity quite literally goes to ground, where it dissipates harmlessly. In most houses, the electrical system is grounded to the metal water supply piping and/or one or more eight-foot metal rods (Grounding Electrodes) driven into the ground. This allows stray electricity to get into the ground. Where grounding is through metal supply piping, the ground wire (Grounding Electrode Conductor – GEC) should be connected to the supply piping near its point of entry into the house. If connected downstream of the water meter or a water filter, a jumper wire is provided across the meter or filter to maintain the connection to ground even if the device is removed.

OTHER GROUNDING ELECTRODE SYSTEMS Other grounding configurations include a well casing, a long copper wire or bar encased in the concrete footing, and a metal plate or ring buried in the ground. None of these is visible and they are not evaluated during a home inspection.

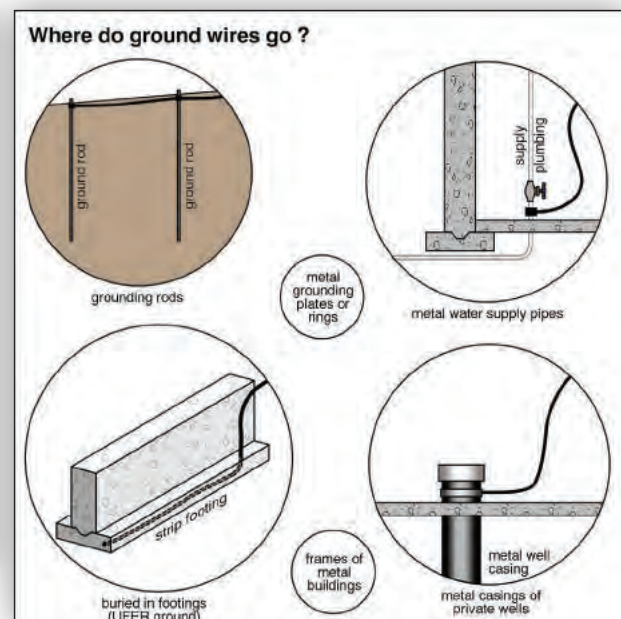
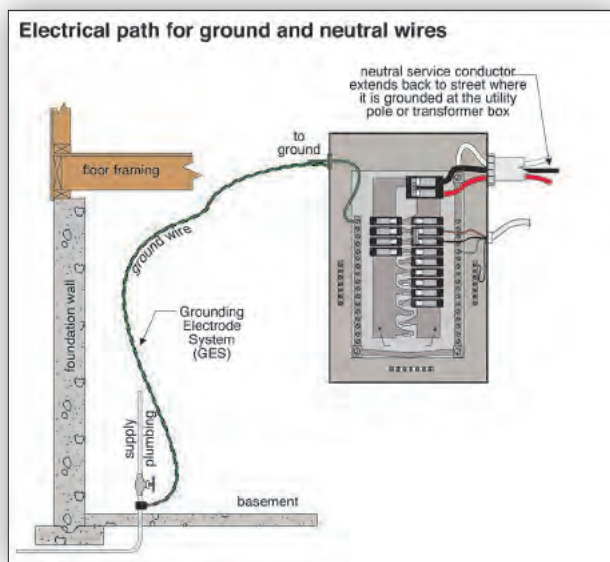

Common Problems with Grounding

MISSING The system ground is missing in some cases. It may have been omitted from the original installation, or removed during electrical or plumbing work; or the original ground may have been left behind when the service panel was relocated. Adding a new ground wire is not usually difficult or expensive.

**WIRE TYPE/
SPLICES** The ground wire may be too small for the service size, the wrong material, or there may be splices. Connections in ground wires are generally discouraged for fear of a bad connection.

**INEFFECTIVE
GROUNDING** The system ground may be ineffective. If the connections are poor or the wires damaged, the quality of ground is suspect. If there is a splice in the ground wire, a potentially weak connection exists. Ground wires are sometimes ineffective because they are secured to pipes that are no longer in service. This is common on galvanized steel plumbing pipes that are abandoned. If the plumber did not move the ground wire over to the new piping, the grounding system will be defeated. By the same token, connecting a ground wire to plastic supply piping is not effective, since plastic is not a good electrical conductor. The ground wire (GEC) may also be too small.

Checking the quality of the grounding system is beyond the scope of a home inspection.

**LACK OF
BONDING** The grounding system has to be continuous. The ground wire has to be bonded to other wires that rely on grounding. The ground wire, the service box, and the neutral wire should be electrically bonded together at the service box, but often are not. This situation should be corrected promptly. Again, the continuity of the system is not verified during a home inspection.

**BONDING AND
GROUNDING** These terms are similar, confusing and often used interchangeably. Strictly speaking, a ground wire connects to ground. Bonding means connecting things electrically so they have the same electrical potential. The things may have a potential of 120 volts, zero volts, or anything else, as long as both are the same. The idea is we don't want electricity flowing between the two. When we bond something to a ground wire, everything is effectively grounded.

**BONDING PIPING
SYSTEMS** Metal pipes for water and gas can become live electrically if something goes wrong. In many areas, the hot water cold water and gas piping are bonded together and connected to the system ground to the house to reduce the risk of electrical shock from piping.

**GROUND WIRE
DOWNSTREAM OF
WATER METER** Connecting the ground wire to the plumbing system downstream of the water meter is not considered effective because stray electricity may not be able to get past the meter to ground, especially if the meter is removed for repair! This can be easily corrected by relocating the ground wire upstream of the meter, or providing a jumper wire around the meter.

NEXT STEPS Now we'll look at the main panel where electricity gets distributed throughout the house.

3.0 Service Panel

3.1 Panel (Panelboard in Electrical Code Terms)

DESCRIPTION Electricity is carried from the service box to the service panel. Modern systems use a combination panel where the service box and service panel are in one box. The black and red wires are each connected to a live connection bar (called a bus bar – a current-carrying metal bar with several connection points) and the white wire is connected to the neutral bus bar. Each branch circuit is connected to one of the two bus bars through a fuse or circuit breaker that protects that circuit.

TYPICAL HOUSEHOLD CIRCUIT (120-VOLT) The black or red branch circuit wire for an individual circuit is connected to its own small breaker (or fuse). The current flows through the bus bar, through the breaker or fuse, and into the black or red wire for the circuit. The electricity flows out, completes its circuit, running through whatever fixtures or appliances are in use on the circuit, and comes back through the white (neutral) wire. The white circuit wire is connected to the neutral bar, which is attached to the service entrance white wire.

It doesn't matter whether power is taken from the black or the red bus bar. The result is the same; a 120-volt branch circuit has been established. The typical 14-gauge copper wire is protected by a 15-amp breaker.

NUMBER OF CIRCUITS Panels may have room for any where from four to 40 circuits. 240-volt circuits for large electric appliances are established by combining a 120-volt black circuit and a 120-volt red circuit.

AUXILIARY PANEL (SUBPANEL) When the service panel is filled, an auxiliary panel can be added. This does not bring more power into the house; it simply allows for more branch circuits. It's like adding more branches to the tree without increasing the size of the trunk.

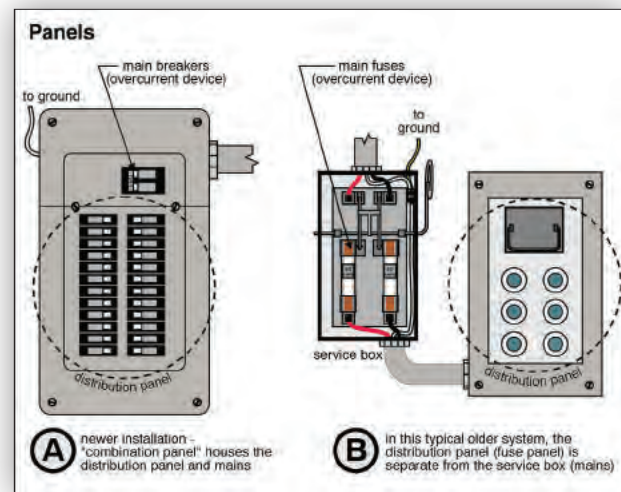

Common Problems with Panels

- DAMAGED/ LOOSE/RUST** Where the panel is damaged mechanically or by water, it should be replaced. Water in the panel causes rust and possible connection problems. Poorly secured panels should be re-secured to the wall.
- OBSOLETE PANEL** Old ceramic fuse-holders, which may or may not be in a metal cabinet, are considered obsolete and unsafe. These should be replaced. These panels, which may be found on walls or ceilings, have exposed terminal connections, and it is easy to accidentally touch a live wire while changing a fuse.
- PANEL COVER MISSING OR DAMAGED** Covers should be provided or replaced as needed. Loose covers should be re-secured to reduce the risk of electric shock. Power should be disconnected prior to removing the cover.
- UNPROTECTED PANEL OPENINGS** There should be no openings in the panel that allow someone to reach in and touch a live electrical component. This may occur where the panel has room for more circuits, or where a fuse block has no fuse. Wherever this situation exists, the opening should be covered or the fuse block fitted with a fuse. Installing a blown fuse on a spare circuit to fill an opening is acceptable.
- Unprotected panel openings may also occur at the sides of the panel, where circuit wires typically leave the panel. Any openings in the side of the panel should be blanked off.
- UNDERSIZED PANEL** Where the panel rating is smaller than the service size, the panel must be replaced with a larger one.
- POOR PANEL LOCATION** Panels are not allowed in clothes closets, bathrooms or stairways, for example.
- POOR ACCESS TO PANEL** The panel should be accessible with the center of the panel roughly five feet above the floor. The three-foot area in front of the panel should be kept clear for service access.
- CROWDED WIRING IN THE PANEL** Panels should not be overfilled with wire. Excess wire in the panel can lead to poor connections and overheating. This can happen if installers do not trim the wire to the right length inside the panel.
- DAMAGED OR ABANDONED WIRE IN THE PANEL** Damaged wire should be replaced. Abandoned wire in the panel may lead to overcrowding or confusion about what is live and what is not. It should be removed.
- OVERHEATED PANEL WIRING** Evidence of overheating including discoloration or melted wire insulation should be investigated by an electrician immediately. It may be the result of a loose connection, mechanical damage, moisture or overloading.
- PANEL WIRING POORLY SECURED** Most wiring leaves the panel through the side of the box. Wiring should be well secured where it leaves the panel. A cable connector is used to make sure the wire is not exposed to the sharp edges of the hole in the box, and to secure the wire so that if someone pulls on the wire, it will not loosen the connections inside the panel. Where these connectors are missing, they should be provided.

- DOUBLED-UP CIRCUITS** People often add circuits as a house expands or as electrical needs grow. In some cases, circuits in the panel are doubled by adding a second wire to the terminal screw for one breaker or fuse.
- DOUBLE-TAPS, DOUBLE-LUGS** This double-tapping or double-lugging is not permitted and should be corrected. The most common solution is adding an auxiliary panel. Replacing the existing panel with a larger one is acceptable but more expensive. This makes sense if the existing panel is damaged or very old.
- Some manufacturers have a special circuit breaker designed to hold two wires. Some authorities do not accept these types of breakers. Securing three wires under one terminal screw is never acceptable.
- UNDERSIZED WIRE FEEDING AUXILIARY PANEL** Where an auxiliary panel is used, the wire from the service panel to the auxiliary should be protected by breakers or fuses in the main panel. The wire size should be large enough to carry the load from the auxiliary panel. If the auxiliary panel is rated at 60 amps, the wire feeding it should also be rated at 60 amps. This would be a 6-gauge copper wire.
- INAPPROPRIATE BONDING AT THE AUXILIARY PANEL** The ground wire and neutral wire should not be bonded together in an auxiliary panel. This may turn the grounding wire into a current-carrying wire inadvertently, creating a dangerous situation.
- SUSPECT PANEL** Some electrical panels have been the subject of some controversy and there have been recalls.

3.2 Fuses and Breakers

- DESCRIPTION** Fuses and breakers perform the same function. They are the brains of the electrical system and shut off the circuit when too much current is flowing. A circuit breaker can be turned back on after the overload situation is corrected. A fuse has to be replaced.
- DANGEROUS PRACTICES** People sometimes get frustrated with fuses blowing. They do not understand that this is signaling a serious problem. Bypassing a fuse is a very dangerous practice. It is foolish to wrap a blown fuse with foil or put a penny in a fuse block. This may cause a fire.
- OVER-FUSING** One disadvantage of fuses is that it is easy to use the wrong size fuse. It is unfortunate that 15, 20, 25 and 30-amp fuses all fit into the same fuse block. An oversized fuse or breaker will not shut off the circuit in time to prevent overheating. Circuit breakers are typically not changed by the homeowner, and are less likely to be incorrectly sized.
- FUSE REJECTORS** Fuse rejector washers are small plastic rings that are inserted into the fuse block. There are different rejectors for 15, 20, 25 and 30 amp fuses. Fuse rejectors prevent the wrong fuse from being screwed into the fuse block.
- TYPE C FUSES** Here's another way to prevent over-fusing: Type C screw-in (plug) fuses are non-interchangeable. This means that the wrong size fuse will not fit into the fuse holder.
- OTHER TYPES OF FUSES** Fuses rated at 15, 20, 25 and 30 amps are glass screw-in type fuses. Larger fuses are always cartridge type with a metal collar at each end. Cartridge fuses are also available in smaller sizes.
- TIME DELAY (TYPE D) FUSES** When electric motors start up, they draw a lot of electric current for a very short time. In some cases this can lead to nuisance fuse blowing. Special time delay (Type D) fuses allow this extra electricity for a very short time. This is okay, because things will not overheat in a second or two. Circuit breakers have this time delay feature built in.

TYPE P FUSES Type P fuses have an added safety feature. The low melting temperature of this fuse senses heat build-up around the fuse, which may be caused by a poor connection between the fuse itself and the fuse holder. Poor connections can overheat and cause fires with current flows that are too small to blow a fuse.

WHICH CIRCUIT IS OFF? Most circuit breakers trip by moving the switch to the middle position, others simply switch to the off position. It is usually very easy to see which circuit breaker has tripped. The circuit is re-activated by simply ‘switching’ the breaker off and on again. With fuses, it is not always easy to see which one has blown. On glass fuses, you can usually see if you look closely through the glass, but on a cartridge type fuse it is often difficult to know.

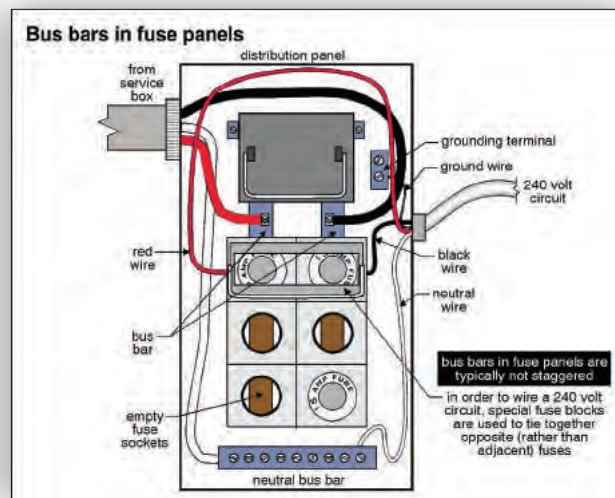
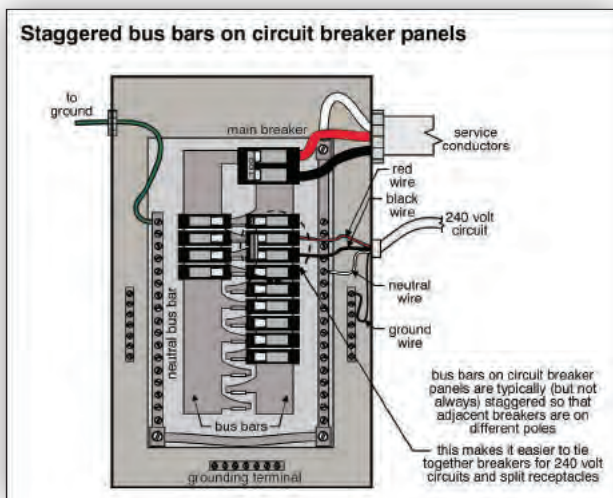

Common Problems with Fuses and Breakers

OVER-FUSING The most common flaw with fuse panels is fuses that are the wrong size for the wire. This unsafe condition should be corrected promptly to prevent overheating of the wire. The illustration below shows the appropriate size of fuse for given wire sizes.

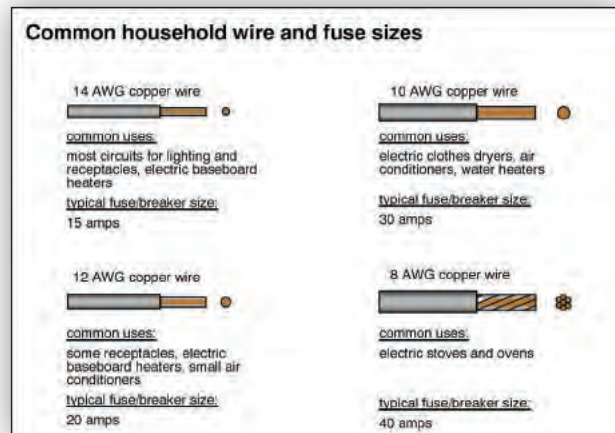

- DAMAGED OR LOOSE** A broken or damaged fuse holder or circuit breaker may not operate properly and should be replaced. Poorly secured fuse holders or circuit breakers may result in poor connections and should be re-secured or replaced.
- DOUBLED-UP CIRCUITS** People often add circuits as a house expands or as electrical needs grow. In some cases, circuits in the panel are doubled by adding a second wire to the terminal screw for one breaker or fuse.
- (DOUBLE-TAPS, DOUBLE-LUGS)** This double-tapping or double-lugging is not permitted and should be corrected. The most common solution is adding an auxiliary panel. Replacing the existing panel with a larger one is acceptable but more expensive. This makes sense if the existing panel is damaged or very old.
- (TEXT REPEATED FOR CLARITY)**

Some manufacturers have a special circuit breaker designed to hold two wires. Some authorities do not accept these types of breakers. Securing three wires under one terminal screw is never acceptable.

3.3 240-Volt Circuits and Multi-wire 120-Volt Circuits

- DESCRIPTION** Heavy duty appliances use 240-volts. These include electric ranges, ovens and cook tops, clothes dryers, electric furnaces and heaters, air conditioners and water heaters. Here, the black wire and red wire are both used in the circuit. For most of these appliances, a white neutral wire is also used.

Multi-wire 120-volt circuits use cables with the black, red and white conductor. At some point in the circuit, these split into two 120-volt circuits. These circuits can be used to reduce the amount of wire that has to be run throughout the house. These are common for dishwashers and garbage disposals, for example. They may also be used at kitchen receptacles. The top half of the receptacle can be on one circuit and the bottom half can be on another. This allows the two appliances to be plugged in to the same outlet without blowing a fuse or tripping the breaker. These circuits have two fuses or breakers, just like 240-volt circuits.

Two breakers (or fuses) are needed; one for the black wire, and one for the red wire. These two breakers (or fuses) should be linked so that if one is switched off (breaker) or pulled out (fuse), the other must be switched off or pulled out with it. This is a safety feature to prevent electric shocks. If only one part of the circuit was turned off, there would still be power to the other part. It would not be safe to work on the system.

Circuit breakers should have mechanical ties or links to make sure both are turned off. There are also special double circuit breakers with a single handle. With fuses, double fuse holders are used that must be pulled out together to disconnect the circuit.

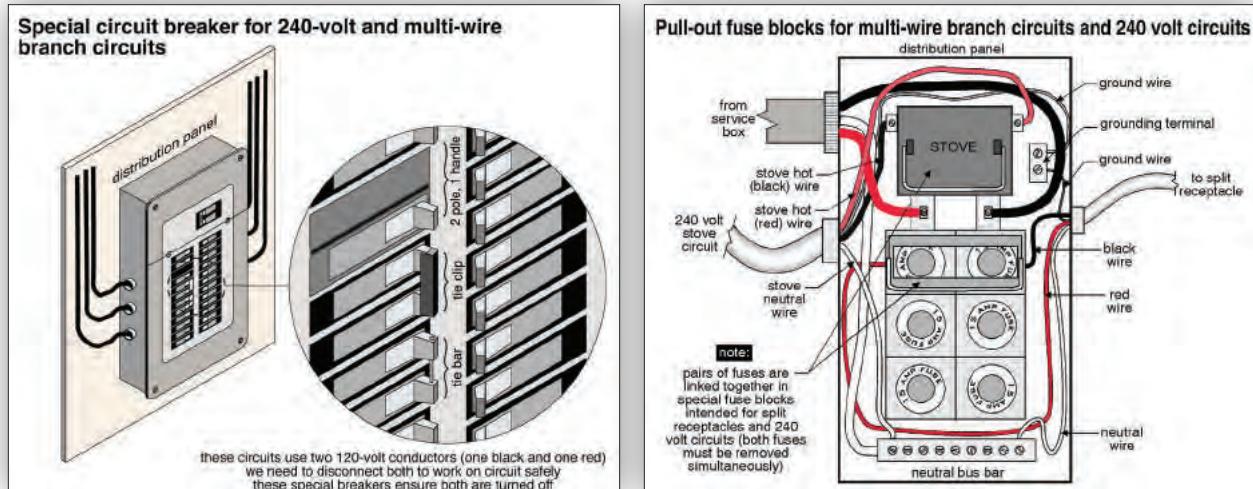

The Common Problem with Multi-wire Circuits

MISSING LINKS FOR BREAKERS OR MISSING PULLOUTS FOR FUSES The most common issue with 240-volt circuits and multi-wire 120-volt circuits is the absence of the device to make sure both circuits are turned off. In most cases, this important safety improvement is inexpensive.

NEXT STEPS Before we move on and look at the wiring throughout the house, we are going to look at a couple of other devices that help circuit breakers and fuses make houses safer – ground fault circuit interrupters and arc fault circuit interrupters. The names are confusing but the concepts are simple.

3.4 Ground Fault Circuit Interrupters

DESCRIPTION These safety devices have been around since about 1970. They improve the safety of regular circuit breakers and fuses by reducing electric shock hazards. Instead of looking for too much current flowing, they look for current going where it's not supposed to go. They shut the power off when as little as .005 amps are leaking. Under normal circumstances, the same amount of current is flowing at any point in the circuit. If there are five amps flowing out through the black wire, there should be five amps coming back through the white wire. If there is a difference, current is escaping somewhere, and this is dangerous. The GFCI shuts down the circuit when it measures different currents in the black and white wires.

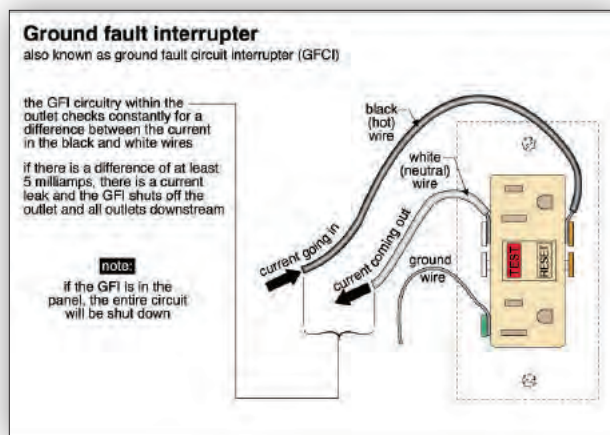

Modern electrical codes require ground fault protection where there is the potential for water to come into contact with electricity. This includes receptacles for bathrooms, kitchen countertops, wet bars, laundry tubs, spas and hot tubs, whirlpool baths, swimming pools, unfinished basements and outdoor receptacles.

Protection may be provided by GFCI circuit breakers or receptacles. GFCI circuit breakers at the panel protect the entire circuit. GFCI receptacles protect only that outlet, and the downstream outlets on that circuit. Note: we use the terms receptacle and outlet interchangeably, as most home owners do.

While electrical codes require these devices in new work, they do not require them on existing installations, although the extra protection afforded by these devices is desirable. Code requirements for GFCIs have changed several times since they were introduced in 1970.

IDENTIFICATION Ground fault circuit interrupter breakers at the panel can be identified by the Test and Reset buttons. Ground fault interrupter receptacles can also be identified by the Test and Reset buttons.

Common Problems with Ground Fault Circuit Interrupters

MIS-WIRED In addition to the normal problems that may be the result of mis-wired electrical receptacles, a mis-wired GFCI receptacle may not shut off the circuit as expected. A common problem is the reversal of the “line” and “load” connections on the back or sides of the outlet. Newer GFCI receptacles will not reset if the wiring is done improperly. Correcting this problem is quick and inexpensive.

MISSING GFCIs may not be provided in new work as required by local jurisdictions. Replacing conventional breakers with GFCI breakers is not difficult, although GFCI breakers are more expensive.

TEST FAULTY/ INOPERATIVE GFCIs have a test button that simulates a ground fault situation. Pressing this button will cause the breaker to trip if it is working properly. If the test button does not trip the breaker, the device may have to be replaced. Since this test turns off the power to everything connected to the circuit, many home inspectors do not perform this test.

There may be no power to the GFCI. A specialist should be engaged to investigate.

3.5 Arc Fault Circuit Interrupters

DESCRIPTION Arc Fault Circuit Interrupters (AFCIs) help protect against fires by detecting arcing. Arcing is an electrical problem that occurs when electricity jumps from one conductor across an insulator to another conductor. Light and heat are generated as the current passes through the insulator, which may be air or a solid insulating material. Arc faults are common where electrical cords are damaged, or where outlets are not properly installed.

GFCIs are designed to prevent electrical shock. AFCIs are designed to prevent fires. GFCIs look for electricity that is not where it's supposed to be by measuring current running through wires. AFCIs look for overheating by monitoring the waveform of the circuit voltage.

Arc faults are dangerous because the heat generated may ignite nearby combustible material, starting a fire. Arc fault currents are often too small to trip a breaker or blow a fuse. A GFCI will not detect arc faults. An AFCI breaker protects the entire circuit.

WHERE NEEDED In houses built since roughly 2001, AFCIs have been required on circuits serving bedrooms. In some areas, codes have extended this requirement to other areas in the house, such as living rooms, dining rooms and hallways. They do not have to be added to existing installations.

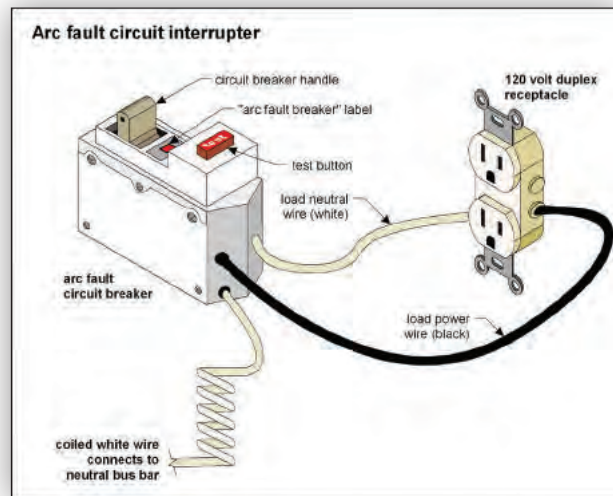

Common Problems with Arc Fault Circuit Interrupters

- MISSING** AFCIs may not be provided in new homes as required by local jurisdictions. Replacing conventional breakers with AFCI breakers is not difficult, although AFCI breakers are more expensive than conventional breakers.
- FAULTY** AFCIs have a test button to simulate an arcing situation. Pressing this button will cause the breaker to trip if it is working properly. Since this turns off the power to everything connected to the circuit, many home inspectors do not perform this test.

4.0 Branch Circuit Wiring

4.1 Branch Circuit Wire: (Distribution Wiring)

- DESCRIPTION** The wire carrying electricity from the panel to the fixtures and appliances is typically copper, although aluminum was commonly used from the mid-1960s to the late 1970s. Each post-1960 cable is made up of two conductors and one ground wire. Pre-1960 installations did not include a ground wire in each branch circuit. (Notes: Dates are approximate. We use the terms wire and conductor interchangeably.)
- The conductors are wrapped with color-coded plastic insulation. On older wiring, the insulation was rubber. The ground wire is not insulated. This group of three wires is typically wrapped in a plastic or nylon sheathing. Older sheathings were paper, cloth and rubber. Flexible metal cable and rigid metal conduit are also used as sheathing.
- BLACK AND WHITE WIRE** One conductor has black insulation and is the live or hot wire. The other conductor has white insulation and is referred to as the neutral. Neither wire should be touched when there is power to the circuit. The black and white wires carry the current. The voltage available is 120 volts, and the current flow is less than 15 amps.
- GROUND WIRE (EQUIPMENT GROUNDING CONDUCTOR – ECG)** The ground wire is normally idle. If there is a problem, the ground acts as an escape route for the electricity, inducing the current to flow through this wire to the ground, rather than into a person, causing an electrical shock. Grounded distribution wiring was introduced to residential electric systems in the late 1950s.
- THREE CONDUCTOR CABLE** 240-volt circuits and multi-wire 120-volt circuits have an additional live or hot wire, as we have discussed. This cable contains a black, red, and white insulated wire as well as an uninsulated ground wire.
- WIRE GAUGE** The normal wire size is 14-gauge. This is capable of carrying 15 amps safely. A fuse or circuit breaker rated at 15 amps should always be provided on a 14-gauge copper circuit. In some cases, 20-amp circuits serve kitchen or other outlets. The copper wire size for these circuits should be 12-gauge.

- DEDICATED CIRCUITS (INDIVIDUAL BRANCH CIRCUITS)** All 240-volt appliances get dedicated circuits. This includes things like stoves, water heaters, air conditioners, clothes dryers, hot tubs and saunas. Some 120-volt appliances also get a dedicated circuit. This includes such things as the furnace or boiler, dishwasher, food waste disposal, compactor, central vacuum system, microwave oven, refrigerator, freezer, washing machine, whirlpool bathtub, and electric heaters. Split receptacles (outlets where the top and bottom halves are on separate circuits) are also usually on dedicated circuits. Exterior outlets are often on one dedicated circuit. A home inspection will not identify which circuits are dedicated. These are determined when the electrical circuits are labeled.
- NOT A SAFETY CONCERN** Dedicated circuits are rare in older houses and it is very difficult to verify during a visual inspection. It is not a major expense to rearrange this, and the issue is not one of life safety, simply a matter of convenience. Without dedicated circuits for each of these appliances, there is the possibility of nuisance fuse blowing or circuit breaker tripping with several appliances in use simultaneously.
- REFRIGERATOR AND FREEZER** The reason a refrigerator or freezer gets a dedicated circuit is to prevent food spoilage. If it is on a circuit with other appliances, the fuse or breaker may be blown as a result of a problem with another appliance. The fuse or breaker may not be replaced immediately if the homeowner doesn't know that the refrigerator or freezer is also on this circuit. As a result, food may be spoiled. Again, home inspectors will not pick this up.
- FURNACE OR BOILER** The heating system should be on a dedicated circuit. If the heating system was to shut down due to an overload from another appliance, the house would be without heat. This can result in freezing if the home is unoccupied for some time.
- HEAVY CURRENT DRAW** Some appliances need dedicated circuits because of their heavy electrical draw. Putting additional outlets and lights on the circuit may lead to regular shut-downs.

Common Problems with Branch Circuit Wiring

- DAMAGED** Wire that is damaged or has been overheated should be replaced. Wire that is nicked is smaller in diameter at that spot. The smaller the wire, the more difficult it is for electricity to move through. (The resistance is higher.) This can lead to localized overheating, and eventually a fire.
- OPEN SPLICES** Connections should be made inside panels or junction boxes. Exposed connections are not safe and should be corrected.
- CABLE CONNECTORS MISSING OR INEFFECTIVE** Wire should be protected from the metal edges of panels and boxes with appropriate cable connectors. This is usually done with bushings, grommets or cable clamps. These devices not only protect the wire from the sharp edges, but they secure the wire, so something pulling on the wire will not cause a loose connection. Missing or ineffective connectors should be replaced.

LOOSE OR DAMAGED Wiring which is poorly secured should be re-secured as necessary to protect it from mechanical damage and reduce the risk of electric shock. The wire should be secured where it enters a panel, junction box or fixture. The wire should be secured within 12 inches of the box, and every four and a half feet to five feet thereafter.

If cable staples are used, only one wire should be secured under each staple. Staples should be the appropriate size for the wire. Inappropriate stapling can damage the cable, risking overheating or electric shock.

EXPOSED TO DAMAGE Wires should not be exposed to mechanical damage. Wires should be run through joists in unfinished basements, rather than on the underside, where they are more likely to be damaged. Wires should be set well back from any nailing surface in stud walls, to avoid a nail being driven into the wires. Alternatively, steel plates should be used to protect the wires from nails or screws.

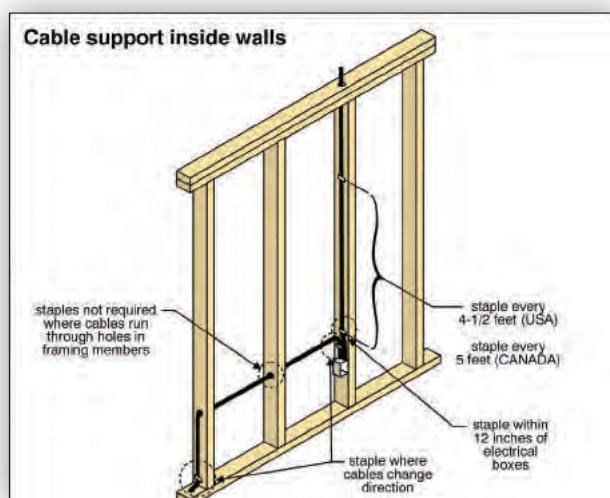

Wire should not be run along interior surfaces of walls, floors or ceilings in finished areas.

EXPOSED IN ATTIC Ideally, the joists should be drilled and the cables should be run through them. Although very common, it is considered poor practice to secure the cable to the top of the joists.

DON'T WALK THROUGH INSULATED ATTICS Walking through an insulated attic where you can't see what you are stepping on is very dangerous because wiring is often run along the top of the attic for joists or trusses. That's why home inspectors don't do it, and you shouldn't either.

DAMAGED INSULATION The wiring may be damaged by rodents. Mice and squirrels in the attic, for example, can damage wiring insulation and create a fire hazard. This is often difficult to detect without pulling back the insulation. Where pests are known to have been in a home, an electrician should inspect the wiring.

UNPROTECTED SURFACE WIRING Where wiring is run on the surface of walls, baseboards or other interior finishes, it should be protected from mechanical damage with a rigid covering.

TOO CLOSE TO DUCTS AND PIPING Wiring should be kept at least one inch away from heating ducts and hot water piping to avoid overheating the wire. Insulation can be used to separate these materials.

UNDERSIZED WIRE Wire that is too small for the appliance it serves, or for the rest of the circuit wiring, should be replaced to reduce the risk of overheating.

EXTENSION CORDS USED AS PERMANENT WIRING Extension cords should not be used as permanent wiring, and should never be stapled to walls, floors or trim. Cords should not run under carpets or go through doorways or windows. These practices are fire hazards.

ABANDONED WIRING Wires that are not in use should be removed or the wire ends should be terminated in junction boxes to prevent confusion and electrical shocks.

IMPROPER EXTERIOR WIRING Exterior wiring should be suitable for outdoor use. There are different types of exterior wire for above grade and below ground use. Exterior wiring should be protected from mechanical damage and special exterior junction boxes are required.

Smaller electrical wires (14-gauge, 12-gauge and 10-gauge) are made up of a single solid conductor. Larger wires (8-gauge and larger) are made up of a number of strands of smaller conductors. These stranded wires are much stronger in tension than solid conductors. Solid conductors (10-gauge and smaller) cannot be run as overhead unsupported wiring because the metal may fatigue. Solid conductor overhead wiring should be replaced.

OVERLOADED CIRCUITS While it is difficult to tell from a visual inspection, the number of lights and outlets (receptacles) on any given branch circuit should be such that the circuit will not draw more than the circuit rating (typically 15 amps) under normal circumstances. At a maximum, 12 lights and/or outlets should be connected to each circuit. The practical limitation, however, is if one of the outlets is used for a hair dryer, which may draw close to 15 amps, it is wise to connect the circuit only to other outlets which will be used for very low-drawing appliances such as clocks, radios, televisions, computers or lights. Most circuits serve a combination of electrical receptacles and lights.

TERMINOLOGY DOUBLE-TALK Electricity is confusing, there's no getting around it. Here's an example of what electrical purists call things: Black and red wires are live and are called 'ungrounded' conductors. White wires are neutral and are called 'grounded' conductors. Ground wires are the emergency system and are called 'grounding' conductors. That's just cruel.

4.2 Knob-and-Tube Wiring

DESCRIPTION Knob-and-tube wiring was used in homes until approximately 1950. While different than the wiring that is used now, it is not necessarily inferior. This wire gets its name from the ceramic knobs that secure it and the ceramic tubes that protect the wire as it passes through wood-framing members such as floor joists.

SEPARATE BLACK AND WHITE The black and white wires in knob-and-tube systems are run separately, in two distinct cables. In modern cables, the black wire, white wire and ground wire are all wrapped up in a single cable. It was felt originally, that having the black wire and white wire separate was safer, since there was very little chance of the black and white wires ever touching, creating a short circuit. This has not proved to be a big problem with modern cables.

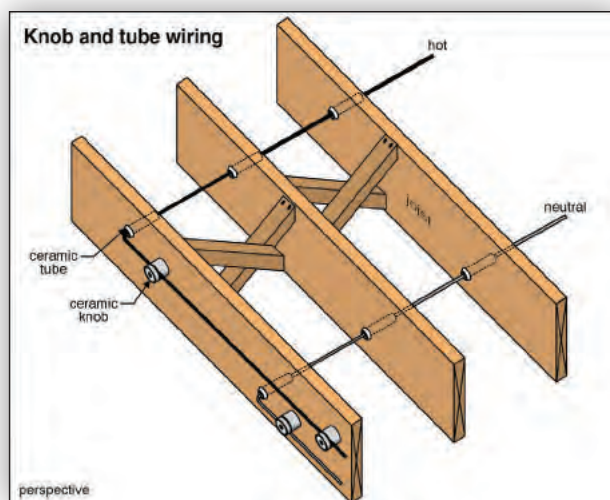

NO JUNCTION BOXES Another difference between knob-and-tube wiring and modern cable is that with knob-and-tube wiring, electrical junction boxes were not used to connect wires. In modern construction, wires must be connected inside a closed box. Knob-and-tube connections were made by twisting the wiring together, soldering the wires, and wrapping the connection in rubber, then in electrical tape. While no longer a common practice, if properly done and not disturbed, these connections will serve indefinitely.

NO GROUND WIRE Another difference between knob-and-tube wiring and modern cable is the absence of a ground wire. As mentioned earlier, knob-and-tube wiring was used up until 1950. From the 1950s to roughly 1960, two-conductor cable was popular, although no ground wire was included. Since roughly 1960, ground wires have been incorporated into the two-conductor cable, and electrical receptacles included a third slot (for the grounding pin) thereafter.

WIRE INSULATION Another distinction between knob-and-tube wiring and some modern cables is in the insulation. The knob-and-tube wiring used rubber insulation and cloth sheathing around the wiring. In modern cables, each wire has plastic insulation typically, and the entire cable is wrapped with another layer of plastic. Over the years, these sheathing materials have included cloth, paper, rubber, metal and plastic.

BRITTLE INSULATION Breakdown of the insulation on knob-and-tube wiring is often the reason it is replaced. This is frequently the result of overheating or mechanical abuse.

REPLACEMENT While knob-and-tube wiring must be recognized as old, it is not necessary to replace it as a matter of course. It should be inspected and evaluated on an individual basis.

Common Problems with Knob-and-Tube Wiring

POOR CONNECTIONS Problems with knob-and-tube wire almost always result from amateurish connections made after original installation. Since original connections were made without junction boxes, many home owners felt they too could make connections to knob-and-tube wiring without junction boxes. This is an unsafe practice, particularly since the chance of making a splice as good as the original connection is very remote. In any case, this violates modern electrical rules.

DAMAGE Since knob-and-tube wiring is invariably old, it has been subject to more home handymen, more mechanical abuse (such as items stored on top of the wire in the basement or attic), and is more likely to have suffered wear and tear. Pinched wiring and damaged insulation is a problem, particularly in unfinished basements, where the wiring is exposed.

BRITTLE Another problem is brittle knob-and-tube wire insulation, which may occur if the wire has overheated in the past as a result of over-fusing, a poor connection or damaged cable. Often the wire becomes brittle in high heat areas, such as panels and junction boxes. In exposed areas, where inspection is easy, there is usually good air circulation and little heat build-up. The wires are least likely to be brittle in these areas.

Brittle wire insulation may be a problem where the wire is buried in attic insulation. This is common in attics where insulation has been upgraded.

CIRCUITS EXTENDED Since older electrical systems had few circuits by today's standards, the chances of each knob-and-tube circuit having been extended over the years are very good. While this is not necessarily a problem, the additional loads and the possibilities of poor connections make an argument for replacing older knob-and-tube wiring. This is often cost-effective during remodeling.

TWO FUSE CIRCUITS (FUSED NEUTRALS) In all modern systems, there is only one circuit breaker or fuse at the beginning of each circuit. There is a very good reason for this. When we want to work on a circuit, we have to turn it off. Using the fuse or circuit breaker is a common way to do that. If the fuse or breaker is at the end of the circuit, turning it off will leave the entire circuit live until we get to the breaker. That makes it very dangerous to work on the system.

Another problem specific to knob-and-tube wiring is the presence of two fuses on a single circuit. Both the black and white wires have fuses on some very old panels. This means there is a fuse at the beginning and at the end of the circuit. If the fuse on the neutral wire blows,

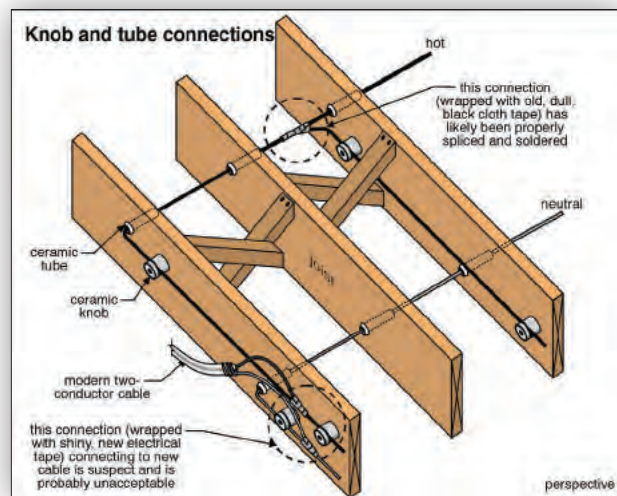

the fixtures and appliances on this circuit will not work. It is not safe, however, to work on the circuit! Power is still available through the circuit, right up to the blown fuse. A person could get a shock in this case. By the way, one fuse on each circuit is perfectly adequate.

We can replace these old panels to solve the problem, without having to replace the knob-and-tube wiring throughout the house.

- INSURANCE DIFFICULTIES** Some companies will only provide insurance after an inspection and approval of the knob-and-tube wiring by the local authorities. Many companies will not offer insurance at all on houses with knob-and-tube wiring.
- REPLACE WHEN REMODELING** It is much less expensive to replace wiring in a home when remodeling a home. Walls, ceilings and floors are opened up and accessible. Many homes with knob-and-tube wiring have the wiring replaced as individual rooms are remodeled. It's very common to find pre-1950s homes with a combination of knob-and-tube and modern wiring.

4.3 Aluminum Wire

- DESCRIPTION** Aluminum wiring was commonly used from the mid-1960s until about 1978. It was introduced because it was less expensive than copper. It was recognized from the start that aluminum wiring is not quite as good a conductor of electricity as is copper. As a result, 12-gauge aluminum was used in place of 14-gauge copper for a 15 amp household circuit. Other wire sizes were also suitably increased. This was fine.
- THERMAL EXPANSION** Some other properties of aluminum, however, were not recognized and did cause problems. Firstly, aluminum has a higher coefficient of thermal expansion than copper. This means that when the wire heats up (as all wire does when electricity flows) the aluminum tends to expand more than copper. This leads to the wire trying to move out from under the terminal screws at connections. This phenomenon is called "creep" and can lead to poor connections and subsequent overheating.
- SOFT** Secondly, aluminum is softer than copper, and electricians used to working with copper would often nick aluminum wiring inadvertently. Nicking the wire, of course, reduces its diameter, and its ability to carry electricity. Localized hot spots can develop where the wire has been nicked. Further, if the wire is bent after it has been nicked, it will often break.
- INSULATING OXIDE** Lastly, the oxide of aluminum that forms on the wire is a very poor electrical conductor. All metals rust or oxidize. The greenish copper oxide that forms on copper wiring is no problem because it is a good electrical conductor. The oxide that forms on aluminum can lead to higher resistance and higher temperatures.
- CU-AL & CO/ALR** As a result of these difficulties, special components, designated CU-AL or AL-CU, were introduced. These components can be used with either copper or aluminum wiring. These included wire connectors (wire nuts), electrical receptacles, circuit breakers, stove blocks, etc. In most cases, these improvements were satisfactory. However, electrical receptacles and light switches continued to be a problem. The subsequently designed receptacles and switches were designated CO/ALR. This designation means Copper/Aluminum Revised.

One alternative to using special components is to join the aluminum wires to short “pig-tails” of copper wire just before they connect to outlets, distribution panel terminals, and so on. The connection between the aluminum and copper wire is made with a connector known to be appropriate. There are connectors specifically approved for this purpose.

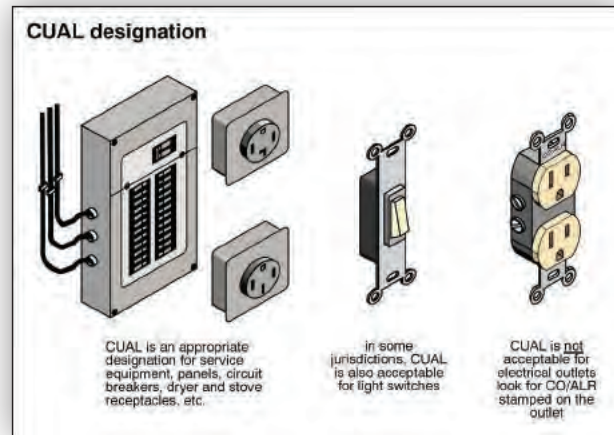

SPECIAL SYSTEMS There were some special systems developed to connect copper and aluminum wire. Many are no longer available and installations are typically evaluated individually by an electrician.

ACCEPTABLE As long as proper connectors are used, and the connections are made without damaging the wire, aluminum wiring is considered safe. It is permitted for use by electrical codes, although it is not commonly used in homes due to the adverse publicity it received during its early problem years. It is still used commonly by utilities in street wiring and for service entrance cables. In some areas, aluminum is still commonly used for 240 volt appliances like ranges and air conditioners.

Common Problems with Aluminum Wiring

PANEL/BREAKERS/ RECEPTACLES/ CONNECTORS – NOT PROPERLY RATED Where special devices or connectors have not been provided for aluminum, they should be added. It is often difficult to know whether the small twist-on connectors are appropriate. The safest thing is to replace them with those known to be appropriate. For example, the small twist-on connectors are so small that they are not marked CU-AL. They are now color-coded, but on older ones it is difficult to know whether or not they are appropriate. Since they only cost a few cents each, it makes sense to replace them with those known to be the correct type. Some experts do not consider twist-on connectors to be appropriate for use with aluminum wire.

INSPECTION BY SPECIALIST RECOMMENDED The examination of every electrical connection in the home is not part of a home inspection. The provision of special aluminum compatible connectors is not an expensive undertaking. We recommend that the specialist check all the devices in the home of aluminum wiring and make improvements as needed.

OVERHEATING Aluminum wires that show evidence of overheating should be further investigated by a specialist. There may or may not be a significant problem.

ANTI-OXIDANT MISSING Connections on large gauge aluminum wires are typically coated with a special grease to prevent corrosion. Where this is missing, aluminum oxide may build up and the wires may overheat.

NEXT STEPS We've talked about everything right up to and including how we get electricity through the house. Now we'll have a look at the endpoints where it gets used.

5.0 Outlets, Lights, Switches And Junction Boxes

5.1 Outlets (Receptacles)

- DESCRIPTION** Electrical outlets are used to plug in portable lights, appliances, heaters, etc. Most outlets are duplex, meaning that we can plug in two appliances. They are usually located in walls, but can also be installed in ceilings and floors in special cases. An adequate number of convenient receptacles is a distinct advantage for today's lifestyles. Situations that require extension cords are inherently dangerous.
- THE RULES KEEP CHANGING** The rules around electrical outlets change regularly. Most existing houses will not comply with the most current code requirements. While improvements are possible, this is not considered a defect.
- POLARIZED** Until 1960 most receptacles were ungrounded. They had only two slots in them, one connected to a black wire and one connected to a white. Outlets typically have the two slots in different sizes, (polarized receptacles) so that a polarized appliance could only be installed in the proper orientation. The smaller slot is designed for the black wire (hot or live wire) and the larger slot is connected to the white (neutral wire).
- LIGHT SOCKET POLARITY** Polarity is important on some appliances. In some cases, polarity is important for safety. In others it is important for proper operation of the appliance.
- A lamp is a good example of an appliance that has a polarized plug for safety reasons. There are two electrical components of the light socket that may be live electrically. The threaded collar around the socket is one half of the connection, and the brass button at the bottom of the socket is the other connection. A person is much more likely to touch the threaded collar that comes up to the top of the socket when replacing a light bulb, so it is safer to make that the white (neutral) connection. The black (live) connection at the bottom of the socket is less likely to be touched.
- Some home entertainment systems require polarized connections to operate properly.
- BLACK TO BRASS** Many modern outlets have a brass colored screw on one side to which the live (usually black) wire is connected. The white (neutral) wire is connected to the silver colored screw on the opposite side, and the ground wire is connected to the ground screw (usually green) near the end of the outlet.

PUSH-IN, BAYONET OR DAGGER Some modern outlets do not have screws on the sides to hold wires in place, but have holes in the back, into which the wires are fitted. These are called bayonet, dagger or push-in type connectors, because of the way the wire is inserted. These outlets were particularly troublesome when used with aluminum wire.

TAMPER RESISTANT Tamper-resistant receptacles are designed to prevent children from inserting things like paper clips or keys into the receptacle. An internal mechanism will block such attempts unless both prongs of a plug are inserted into the outlet at the same time.

GROUNDING OUTLETS The grounding of electrical outlets, which became popular after 1960, affords additional protection. The ground wire is a third wire that normally conducts no electricity. It is an escape route for stray electricity, in case something goes wrong with the appliance or receptacle. When an appliance malfunctions, a cord is damaged, a connection comes loose or a receptacle is faulty, a person touching a live electrical component may get a shock. The ground wire provides a safe path for the electricity, so it does not flow through a person touching the system.

Grounded receptacles are only useful for appliances with grounded plugs. There are very few home appliances with grounded plugs. These include refrigerators, washing machines, microwaves, waterbed heaters, some computers, some small kitchen appliances and some power tools, for example. Grounded plugs also control polarity, since appliance plugs can only be put into outlets one way.

GFCIS AS AN ALTERNATIVE A ground fault circuit interrupter (GFCI) on an ungrounded circuit will improve the safety of the system. Many electrical authorities will now accept ground fault circuit interrupters as an alternative to grounding in existing homes. GFCIs can be installed at the panel or as GFCI receptacles. Some authorities may not accept GFCI receptacles. For more information about how ground fault circuit interrupters work, see 3.4 in this chapter.

20-AMP RECEPTACLES FOR KITCHENS 20-amp receptacles are protected by a 20-amp breaker and the wire size for 20-amp circuits is 12-gauge, rather than 14-gauge. 20-amp receptacles are easy to identify because the larger (neutral) slots are T-shaped. These receptacles are also common in laundry areas and bathrooms where high-current small appliances are common – kettles, toasters, hair dryers, etc. Receptacles rated at 15 amps may be found on 20-amp branch circuits.

Common Problems with Outlets (Receptacles)

UNGROUND Where only two-prong appliances are used, this does not pose a hazard. However, where three-prong plugs (grounded appliances) are used, the outlet should be grounded. A special ground wire can be added, but this is expensive and rarely done. The ground fault circuit interrupter provides improved safety, but it is not quite a replacement for grounding.

POOR LOCATION Outlets should not be installed horizontally in floors or countertops unless they are a special type suitable for this application. Moisture can create an electrical hazard. For the same reason, outlets should not be located on countertop surfaces, facing up.

Outlets should not be close to a source of water unless protected by a ground fault circuit interrupter. They should not be directly above kitchen sinks or bathroom basins, for example, where appliance wires may touch water. Outlets should not be above electric baseboard heaters or close to other heat sources, where appliance wires may touch hot surfaces.

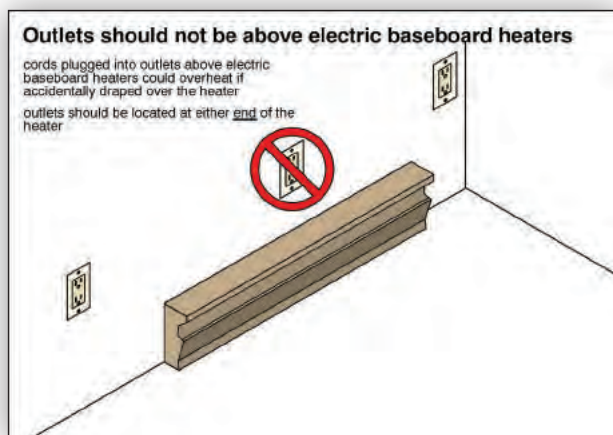

REVERSED POLARITY OUTLETS Modern outlets have a large slot (neutral) and small slot (hot). If the wires are connected improperly, this is referred to as reversed polarity. A reversed polarity outlet can compromise the safety of an electric appliance. A grounded appliance may have its grounding made ineffective by reversed polarity.

With reversed polarity outlets, it is possible for some appliances to have their housing become live in the event of a malfunction. It is also possible for some electrical equipment to operate improperly with reversed polarity. This may include a home computer, a stereo system, etc. Corrective action simply involves connecting the wires to the correct terminals on the outlet (black wire to the brass terminal and white wire to the silver terminal).

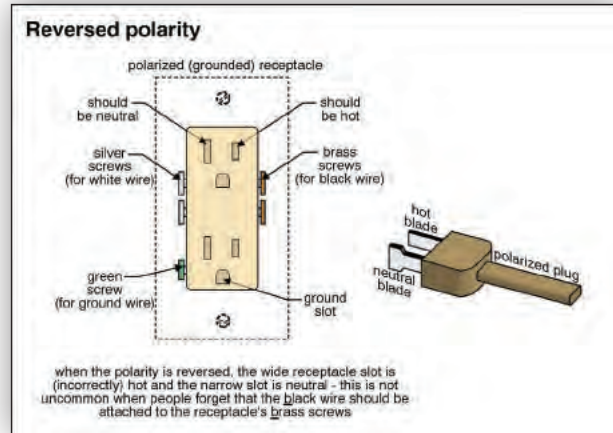

NUMBER OF OUTLETS There should be receptacles wherever people are likely to plug things in. In new construction, there should be an outlet within six feet horizontally of any point along the wall (in finished living spaces). Translated, this means there should be an outlet every 12 feet along the wall. In new kitchens, there should be an outlet within two feet or three feet of any point along the counter.

Older homes will not typically have as many outlets as modern lifestyles demand. Common sense says there should be outlets wherever you need them. If you have lots of extension cords, you need more outlets.

BATHROOMS Outlets should be within three feet of basins, but not directly above the basin. In modern construction, bathroom outlets should be protected by GFCIs.

LOOSE/ DAMAGED/ WORN/ OVERHEATED As outlets wear, they may not hold plugs securely in place. Electrical outlets that are loose or damaged should be repaired or replaced. Similarly, cover plates should be replaced when damaged. Where there is evidence of overheating, a specialist should be engaged to investigate.



WEATHER-TIGHT OUTLETS NEEDED Special weather-tight outlets are required outdoors or where water may contact the outlet.

COVER PLATE MISSING/DAMAGED Damaged or missing cover plates should be replaced.

WON'T WORK If an outlet is inoperative, it is possible that:

1. The outlet itself is defective.
2. The wires inside the box at the outlet are not properly connected. (Intermittent problems usually mean a loose connection.)
3. There is a problem in the wire between the panel and the outlet (perhaps at another box upstream).
4. There is a blown fuse or tripped breaker in the panel.
5. There is a poor connection or damaged wire in the panel.
6. The power has been turned off.

5.2 Lights (Luminaires in Electrical Code Terms)

DESCRIPTION Installed lighting may take the form of traditional ceiling-mounted fixtures, recessed lighting, combination lights and fans, or any number of architectural options. There are several types of lighting fixtures including incandescent, fluorescent, LED (light emitting diode) and halogen.

Common Problems with Light Fixtures

DAMAGED/ POORLY SECURED/ OVERHEATING Damaged light fixtures may present a fire or shock hazard and should be replaced. Light fixtures should be well secured to junction boxes. They should never be supported by the wiring. Light fixtures should be arranged so that they are not susceptible to overheating. Some fixtures require clearance from combustibles to prevent overheating, and some can only be installed in certain orientations.

MISSING When light fixtures are removed, sometimes open junction boxes are left with live wires in them. This is not safe and the box should be covered.

Lights should be provided for all exterior entrance doors, so people can enter safely at night.

WON'T WORK Inoperative lights may be the result of –

1. A burned out bulb.
2. A faulty light fixture.
3. A poor connection in the box.
4. A flaw in the wiring leading to the box.
5. A problem with the switch controlling the light.
6. A problem with the wire between the panel and the switch.
7. A blown fuse or tripped breaker.
8. A poor connection within the panel.

If the problem is not simply a burned out bulb or a blown fuse, you may need an electrician to resolve the difficulty.

FLICKERING LIGHTS Flickering lights may indicate dangerous conditions including poor connections. These should be investigated promptly by an electrician.

POT LIGHTS (RECESSED LIGHT FIXTURES) SHOULD BE CHECKED

Unless they are specially designed for the application, recessed light fixtures should not be installed in areas where insulation will blanket the fixture, impeding normal heat dissipation. This may lead to overheating and is a common problem on the upper floor of the house. Special fixtures typically have a designation that includes the letters IC (Insulation Contact or Insulated Ceiling). These are often not visible to the home inspector. Where pot lights are used in an insulated cavity, an electrician should be engaged to verify the safety of the system.

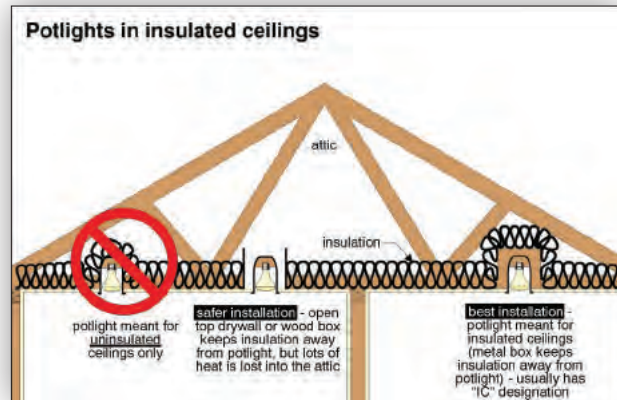

DAMP AREAS NEED SPECIAL FIXTURES Lights used in areas where exposure to water may occur, should be of a special type. This includes lights in shower stalls, saunas and outdoor light fixtures. Again, the home inspector may not be able to determine whether the lights are appropriate for the application.

STAIR LIGHTING SHOULD BE CONTROLLED FROM THE TOP AND BOTTOM Light for stairwells, except for unfinished basements, should be switched at the top and bottom. This eliminates the need to walk up or down poorly lit stairs.

HEAT LAMP PROBLEMS Heat lamps at ceiling level should be located beyond the swing of any doors. If a door is partially open below a heat lamp, a towel or article of clothing flung over the top of the door can be ignited, causing a fire.



- GROUNDING MISSING** Lighting fixtures, outlets, switches and junction boxes should be grounded. Remember, we said grounding was important to carry stray electricity to a safe place, so we don't get an electric shock. Home inspectors don't determine whether light fixtures are properly grounded.
- OBSOLETE** Very old-style porcelain light fixtures, used without electrical boxes, are not safe and should be replaced. Live electrical connections are exposed on these fixtures.
- EXPOSED TO MECHANICAL DAMAGE** Light fixtures in closets are a convenient feature, but the lights must be kept clear of areas where they may be damaged, or where storage may be directly against the light bulb. Lights should not be installed above or beside shelving units in closets, for example. Lights on the wall above the closet door are usually safe. Incandescent bulbs should be fully enclosed, ideally.

5.3 Switches

- DESCRIPTION** Switches may control lights, receptacles, exhaust fans or other installed equipment, such as furnaces and boilers. Ideally, light switches should be placed in areas where they can be easily reached when entering a room, or approaching a set of stairs.
- THREE-WAY SWITCHES** Three-way switches are required in order to control lighting from both the top and bottom of most stairways. Despite their name, there are two switches that control one set of lights. They are also common at either ends of hallways.

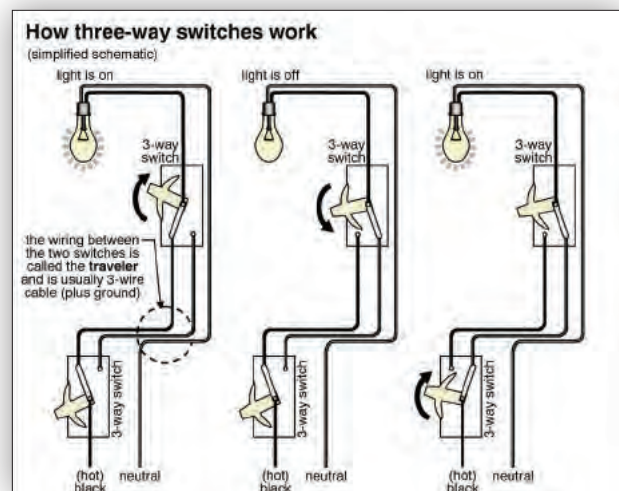

Common Problems with Switches

- DAMAGED/ LOOSE/OBSOLETE** Damaged or loose switches or cover plates should be repaired or replaced. The old push button switches (with two circular buttons which push into the switch and pop out) are generally considered unsafe and should be replaced. Reproduction switches of this type are now approved and available in North America for the architectural purist.
- IMPROPER OPERATION** Any switch that works only intermittently or that causes the lights to flicker should be replaced promptly.

POOR LOCATION Traditionally, switches were located about five feet above the floor. Where access for the disabled is important, switches are typically about four feet above the floor.

Switches in bathrooms should be as far as possible from basins, bathtubs and showers, ideally five feet or more.

IMPROPER STAIRWELL LIGHTING Stairwell lighting should be switched both top and bottom.

SWITCH OR COVER PLATE MISSING/DAMAGED Damaged or missing switches or cover plates should be replaced.

WON'T WORK An inoperative switch may be:

1. A problem within the switch mechanism.
2. A problem with the connections of the wire in the box at the switch.
3. A flaw in the wire between the panel and the switch (including boxes upstream of the switch).
4. A problem downstream in the circuit from the switch that makes it seem like the switch is faulty.
5. A blown fuse or tripped breaker in the panel.
6. A damaged or poorly connected wire at the panel.
7. A burned out light bulb.

An electrician should be contacted to locate and correct the problem.

5.4 Junction Boxes

DESCRIPTION Junction boxes are used to contain and support switches, outlets and lights. They can be metal or plastic, and come in a large variety of shapes and sizes. Junction boxes may also simply contain wire connections. Junction boxes not only protect the connection itself, but secure the wires coming into the box and hold them in place. All modern connections should be made inside a junction box.

Common Problems with Junction Boxes

MISSING Where electrical connections are made with no junction boxes, the danger of electrical shock and fire is increased. With the exception of the early knob-and-tube wiring, all connections should be in junction boxes.

LOOSE Junction boxes should be properly secured to framing members, and wires should be secured to the box, otherwise there is potential for strain on the wires, which may result in loose connections.

- SPECIAL OUTDOOR BOXES NEEDED** Special water-resistant junction boxes are required on building exteriors. This applies to other damp locations as well.
- CROWDED** Every junction box is rated for a certain number of wires of a certain size. Where boxes are overcrowded, there is a danger of overheating and pinching wires.
- NOT ACCESSIBLE** All electrical junction boxes should be accessible for servicing. This means they cannot be covered by plaster, drywall or paneling, for example.
- COVER PLATE MISSING OR DAMAGED** All junction boxes should be provided with cover plates to prevent people touching live electrical connections.

5.5 Appliances

Some appliances have special electrical situations or needs. A few of those are discussed here.

- CEILING FANS** The blades of ceiling fans should be at least seven feet above floor level so that people do not get injured. The fan blades themselves should be 12 inches below the ceiling. Heavy fans should be supported independently of the electrical box.
- AIR CONDITIONERS** The outdoor component of an air conditioning system should have an electric disconnect in a weathertight box. This makes it safe for servicemen to make sure the power is off before working on the equipment.
- GARBAGE DISPOSALS** The cord for a garbage disposal should be no shorter than 18 inches and no longer than 36 inches. It should have a drip loop and in many areas must be armored cable.
- DISHWASHERS** The cord for a dishwasher should be between three feet and four feet long.
- FURNACES AND BOILERS** There should be a disconnect switch within sight of the heating unit.
- WHIRLPOOL BATHTUBS** These should be protected by a ground fault circuit interrupter. The pump motor should be accessible.
- HYDROMASSAGE TUB OR CIRCULATING BATHTUB**